

MEP SmartFilter

MEP SmartFilter est un système de filtration industriel polyvalent. Il est personnalisable pour répondre parfaitement aux demandes spécifiques du client avec un débit d'air allant jusqu'à 10 500 m³ / h.



MEP SmartFilter est un système de filtration industriel polyvalent. Il est personnalisable pour répondre à chaque demande spécifique du client. Convient à différents types de poussières et peut être utilisé dans plusieurs applications différentes telles que le meulage, le grenailage... La conception modulaire permet des solutions autonomes ainsi que des solutions multi-filtres pour de larges exigences. Les poches filtrantes sont disponibles pour la plupart des applications en fonction du type de poussières, du volume ainsi que des exigences d'efficacité. Le MEP SmartFilter est construit en panneaux d'acier galvanisé de 2 mm, il est facile à installer et offre une protection contre la corrosion. Le contrôle Insight Ready avec sa logique de nettoyage par impulsions avancée permet un fonctionnement complet du système, y compris le contrôle et la surveillance, ainsi que la fonctionnalité de passerelle pour la communication dans le cloud. Le MEP SmartFilter dispose d'une large gamme d'accessoires comprenant les ventilateurs, les entrées, les bacs, les poches filtrantes ... et sont disponibles dans une grande variété de matériaux.









- Prenez le contrôle des performances de filtration grâce à Insight Analytics: Technologie de surveillance unique Nederman
- Empreinte optimisée grâce à une conception de poches de filtration innovante avec un flux d'air moyen.
- Coût d'exploitation réduit grâce à un système de nettoyage intelligent, une longue durée de vie du filtre et une empreinte optimisée.
- Système à l'épreuve du temps préparé à l'IoT - Insight Ready

Nom du produit	MEP SmartFilter
Consommation d'air comprimé	58 litres per cleaning pulse at 5,5 bar compressed air
Installation	Intérieur, Extérieur
Matériel	2 mm galvanised sheet metal
Convient pour les poussières combustibles	False
Méthode de décolmatage	Jet d'air pulsé
Application	Fumée, Poussière
Pression de fonctionnement (kPa)	Vacuum max. 6 kPa. Overpressure max. 0 Pa. (1,5 kPa for silotop solution)
Volume du seau (l)	50 or 100 litre bin
Surface filtrante (m ²)	15 - 88
Capacité (débit max m ³ /h)	1800 - 10500
Operating Temperature	-20°C to +70°C
Média filtrant	







Fumée Poussière

MEP SmartFilter

[image]	Nom de la fiche technique	Type de filtre	Nombre d'éléments filtrants	[model]
	MEP-4-4 Smartfilter	Filtre à cassette	4	MEP-4-4
	MEP-6-4 Smartfilter	Filtre à cassette	6	MEP-6-4
	MEP-8-4 Smartfilter	Filtre à cassette	8	MEP-8-4
	MEP-2-6 Smartfilter	Filtre à cassette	2	MEP-2-6
	MEP-4-6 Smartfilter	Filtre à cassette	4	MEP-4-6
	MEP-6-6 Smartfilter	Filtre à cassette	6	MEP-6-6
	MEP-8-6 Smartfilter	Filtre à cassette	8	MEP-8-6
	MEP-2-4 SmartFilter	Filtre à manche ,Filtre à cassette	2	MEP-2-4

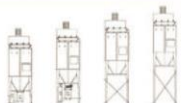
MEP SmartFilter

Accessories

Figure	Description	Figure	Description
	Top mounted FM-fans 50 Hz or 60 Hz up to 14000 m ³ /h		Leg height extensions from 0 mm to 2000 mm to fit larger bins/containers, rotary valves and big bags
	Combifab remote fans 50 Hz or 60 Hz		Leg width extension 300 mm to left, right or both sides to fit larger bins/containers, rotary valves and big bags
	Noise enclosure to reduce fan and motor break-out-noise of FM-fans		Suspension below rotary valve for big bag
	Dual silencer to reduce air flow, fan noise and motor break-out-noise of FM-fans (available with grid (indoor use), grid and rain cover (outdoor use) or flange for duct connection)		Isolation box for pressure tank incl. cleaning valves
	Regulation (iris) damper at fan inlet for FM-fans		Access platform with ladder for maintenance
	Dust bins (50 l, 50 l with wheels and 100 l with wheels)		Lime feeder NFKG-70
	Plastic bag in the dust bin with pressure compensation set 'bin balancing'		Several sensors available for extraction, filtration and discharge process
	Rotary valves NRS3 and NRSZ3		Water separator and pressure regulator
	Dust discharge valve NFUS3		QF-duct system

Envelope material

- NF100 – Polyester needlefelt, singed, 500 g/m²
- NF130 – Polyester needlefelt, glazed, 500 g/m²
- NF141 – Polyester needlefelt, glazed, 400 g/m², antistatic
- NF142 – Polyester needlefelt, glazed, 500 g/m², antistatic
- NF143 – Polyester needlefelt, PTFE coating, 550 g/m², antistatic
- NF180 – Polyester needlefelt, glazed, 550 g/m²
- NF181 – Polyester needlefelt, PTFE coating, 550 g/m²

MEP SmartFilter

A – Height of Clean Air Chamber (mm)

200	350	500	650
Shown in drawings	Add 150 mm in height	Add 300 mm in height	Add 450 mm in height

Filter area

Filter type	Quantity of envelopes	Filter area (m ²)	Max. airflow (m ³ /h)*
MEP-2-4 MEP-2-4-Ex	2	15	1800
MEP-4-4 MEP-4-4-Ex	4	29	3400
MEP-6-4 MEP-6-4-Ex	6	44	5200
MEP-8-4 MEP-8-4-Ex	8	58	7000
MEP-2-6 MEP-2-6-Ex	2	22	2600
MEP-4-6 MEP-4-6-Ex	4	44	5200
MEP-6-6 MEP-6-6-Ex	6	66	8000
MEP-8-6 MEP-8-6-Ex	8	88	10500

*Max. air flow is dependent on the dust type, etc.

MEP SmartFilter

MEP-2-4 / MEP-2-4-Ex

MEP-2-6 / MEP-2-6-Ex

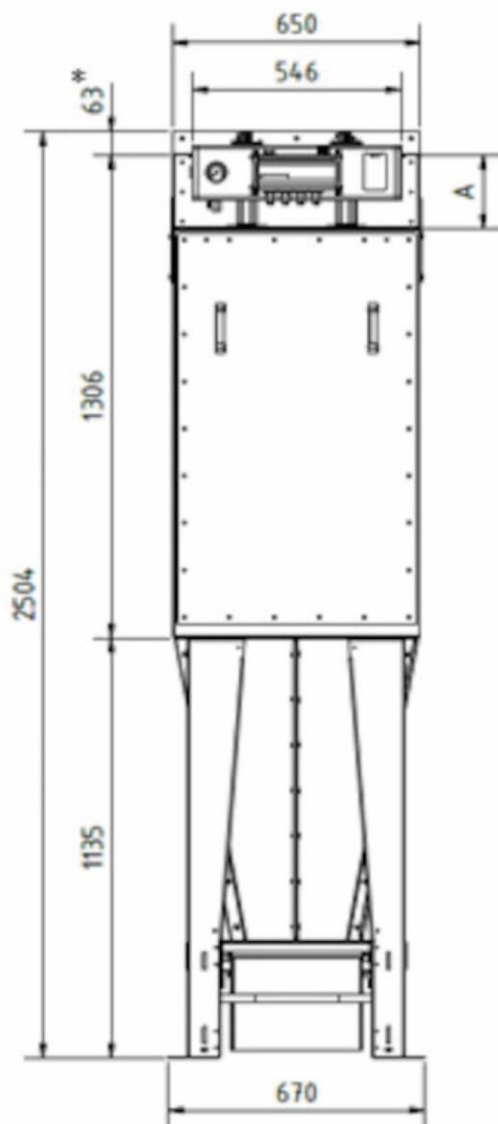

All dimensions in mm.

If 50 liter bin with wheels 90 mm must be added to the height.

* to be included only if a top mounted FM fan is used (transition for fan).

MEP SmartFilter

MEP-4.4 / MEP-4.4-Ex

MEP-4.6 / MEP-4.6-Ex

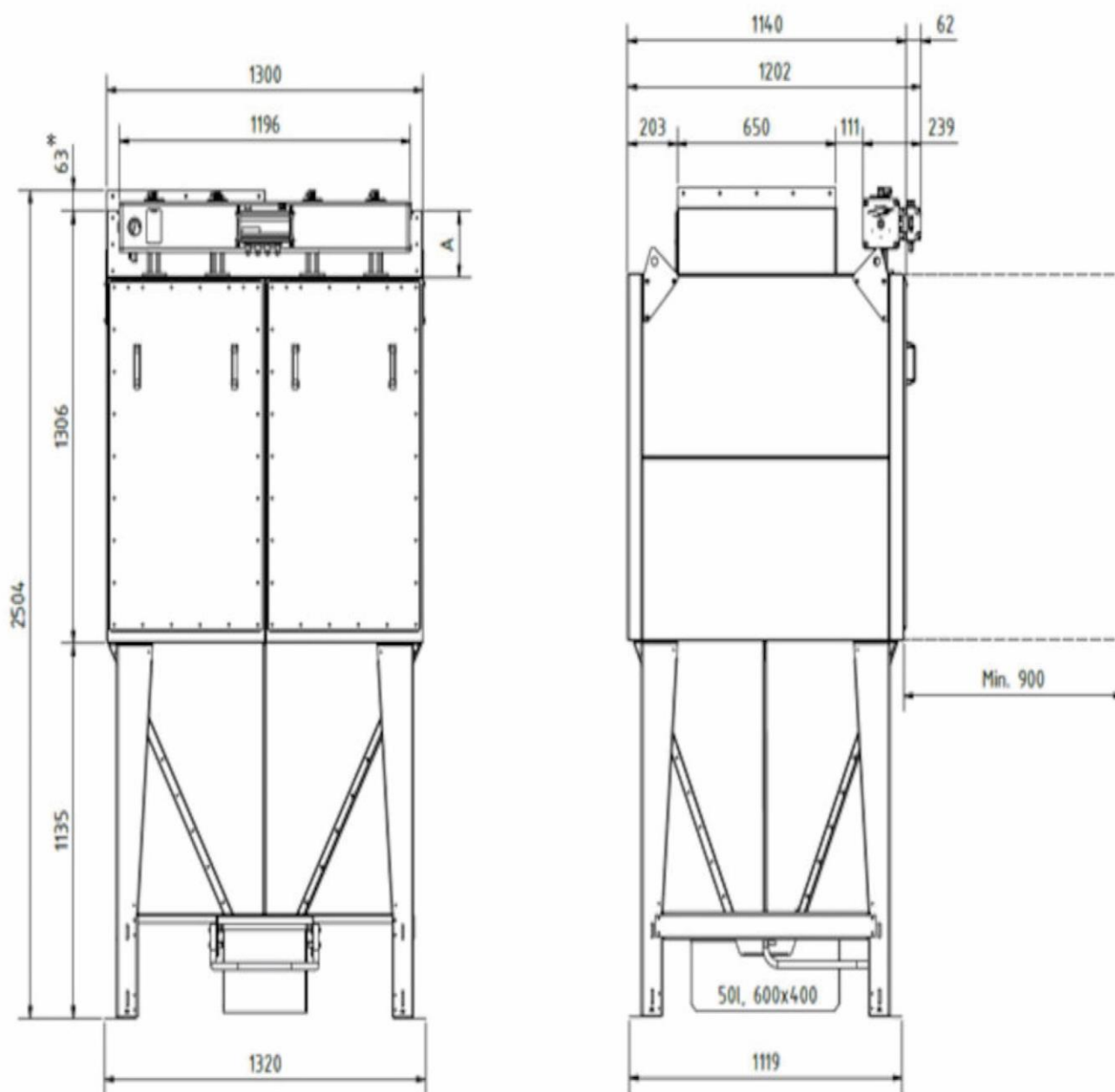

All dimensions in mm.

If 50 liter bin with wheels 90 mm must be added to the height.

* to be included only if a top mounted FM fan is used (transition for fan).

MEP SmartFilter

MEP-8-4 / MEP-8-4-Ex

MEP-8-6 / MEP-8-6-Ex

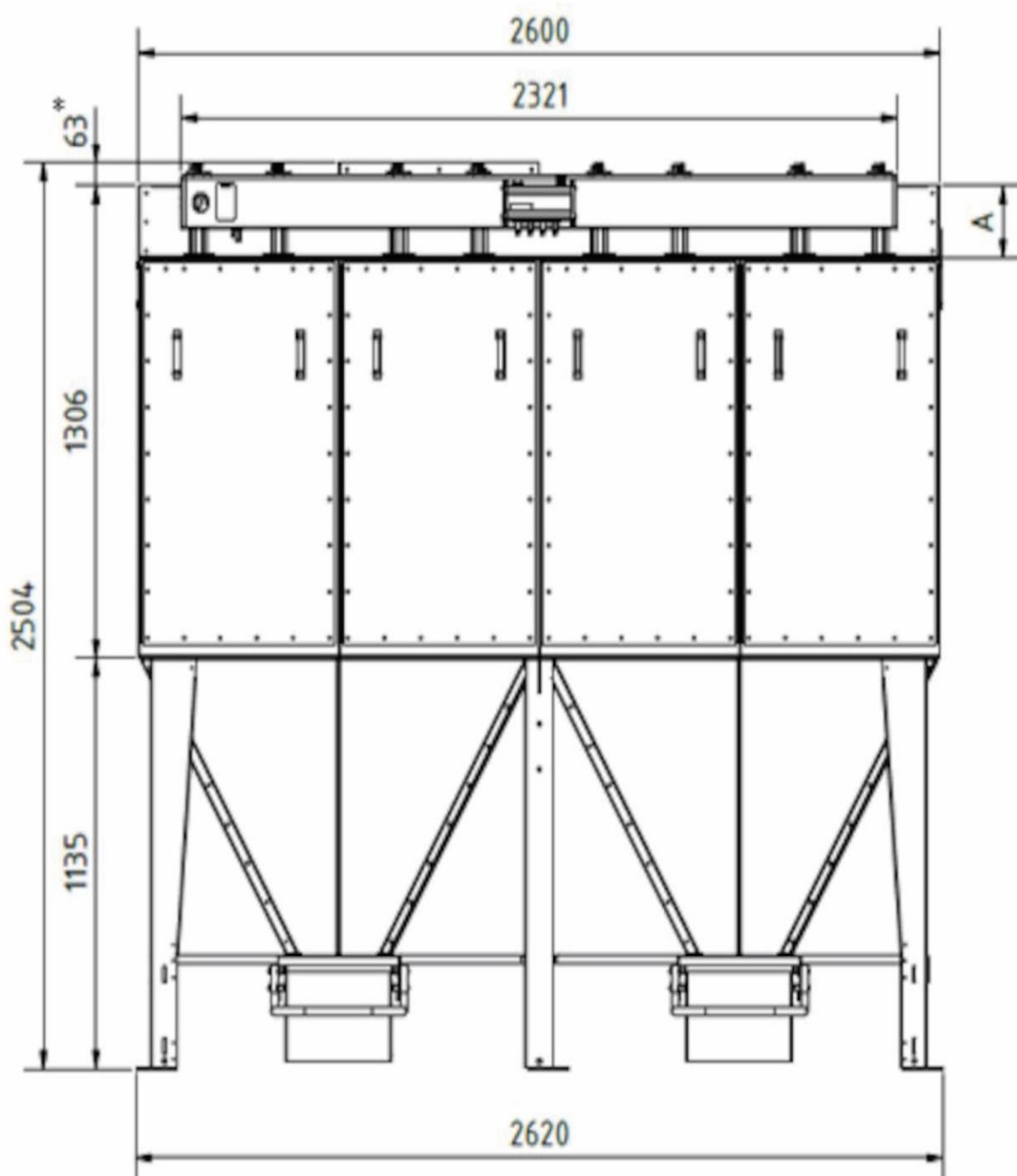

All dimensions in mm.

If 50 liter bin with wheels 90 mm must be added to the height.

* to be included only if a top mounted FM fan is used (transition for fan).

